

REV	ECN. NO.	APP	DATE
A	EDIÇÃO INICIAL		

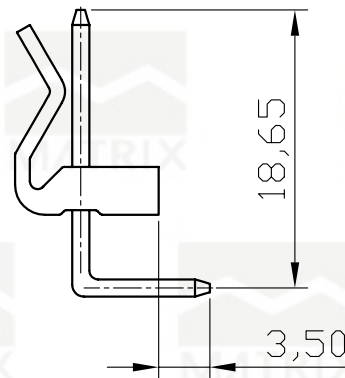

SPECIFICATION

Voltage Rating: 250V AC/DC
 Current Rating: 5A AC/DC
 Temperature Range: -25 ° C ~+85° C
 Contact Resistance: 10 Milliohms Max.
 Insulation Resistance: 1000 Megohms Min.
 Dielectric Withstanding Voltage: 1500V AC/DC/Minute.
 Material: Nylon 66, UL94V-2
 Color: White

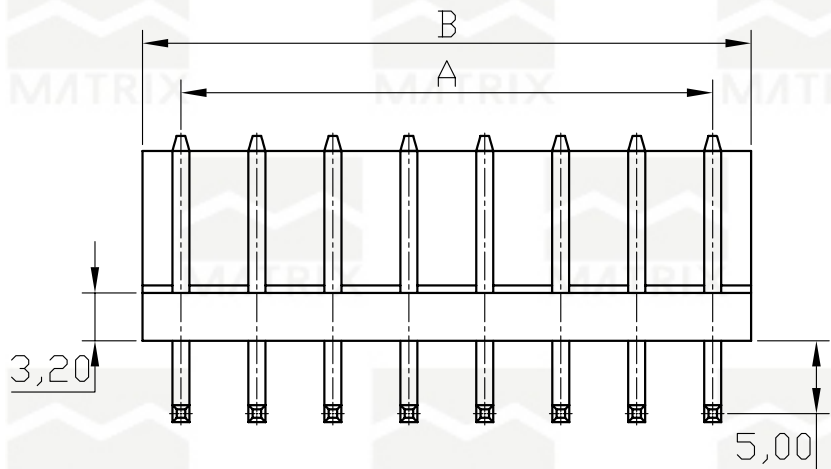
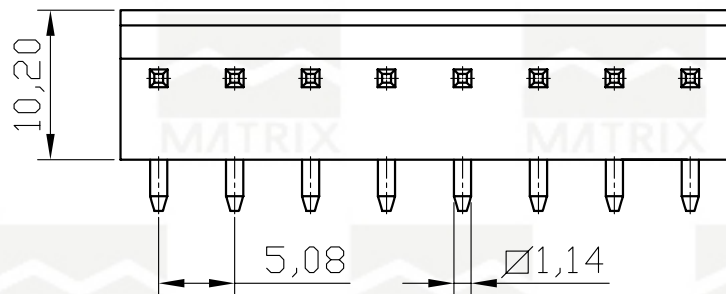

PCB LAYOUT

Dimension		
Poles	A	B
2	5,08	10,22
3	10,16	15,30
4	15,24	20,38
5	20,32	25,46
6	25,40	30,54
7	30,48	35,62
8	35,56	40,70
9	40,64	45,78
10	45,72	50,86

HOW TO ORDER:
MX-5080-W[90]-[]P-[]-[]

1 2 3 4

- 1- Function (90)-90° (180)-180°
- 2- N° of Contact 2 to 10
- 3- Body Option: ()-With Back (N)-Without Back
- 4- (R) RoHS Compliant

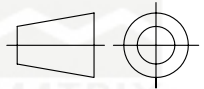
 MATRIX TECNOLOGIA IND. E COM. LTDA.			
UNIT mm	SCALE	TITLE 5,08mm WAFER 90° WITH BACK	DATE OCTOBER 2007
TOLERANCE: ±0.25			APP. BY
		MATL	CHK. BY
DWG. NO.			DR. BY DINO

REV	ECN. NO.	APP	DATE
A	EDIÇÃO INICIAL		

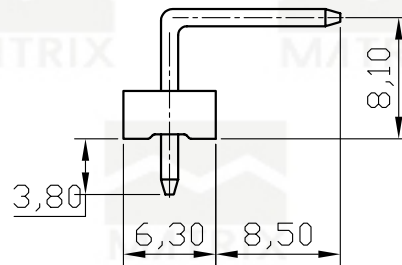
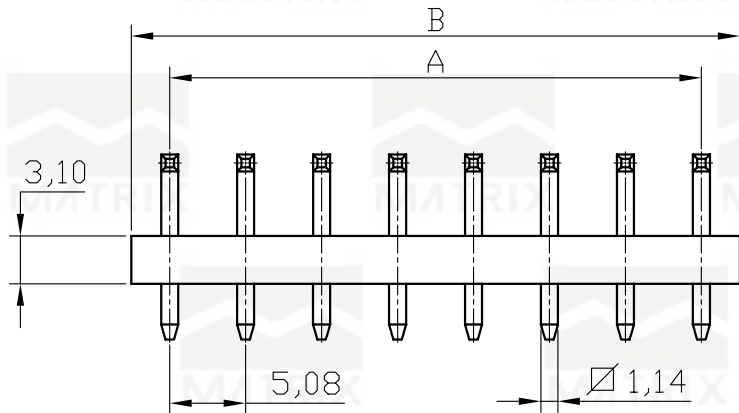

PCB LAYOUT

SPECIFICATION

Voltage Rating: 250V AC/DC
 Current Rating: 5A AC/DC
 Temperature Range: -25 ° C ~+85° C
 Contact Resistance: 10 Milliohms Max.
 Insulation Resistance: 1000 Megohms Min.
 Dielectric Withstanding Voltage: 1500V AC/DC/Minute.
 Material: Nylon 66, UL94V-2
 Color: White

Dimension		
Poles	A	B
2	5,08	10,30
3	10,16	15,40
4	15,24	20,50
5	20,32	25,60
6	25,40	30,70
7	30,48	35,80
8	35,56	41,00
9	40,64	46,10
10	45,72	51,20

HOW TO ORDER:

MX-5080-W[90]-[]P-[N]-[]

1 2 3 4

- 1- Function
(90)-90°
(180)-180°
- 2- N° of Contact
2 to 10
- 3- Body Option:
()-With Back
(N)-Without Back
- 4- (R) RoHS Compliant

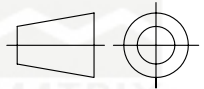
 MATRIX TECNOLOGIA IND. E COM. LTDA.			
UNIT mm	SCALE	TITLE 5,08mm WAFER 90° WITHOUT BACK	DATE OCTOBER 2007
TOLERANCE: ±0.25			APP. BY
		MATL	CHK. BY
DWG. NO.			DR. BY DINO