

REV	ECN. NO.	APP	DATE
A	EDIÇÃO INICIAL		

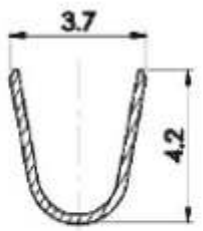

SEC. A-A'

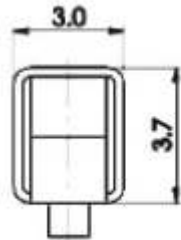
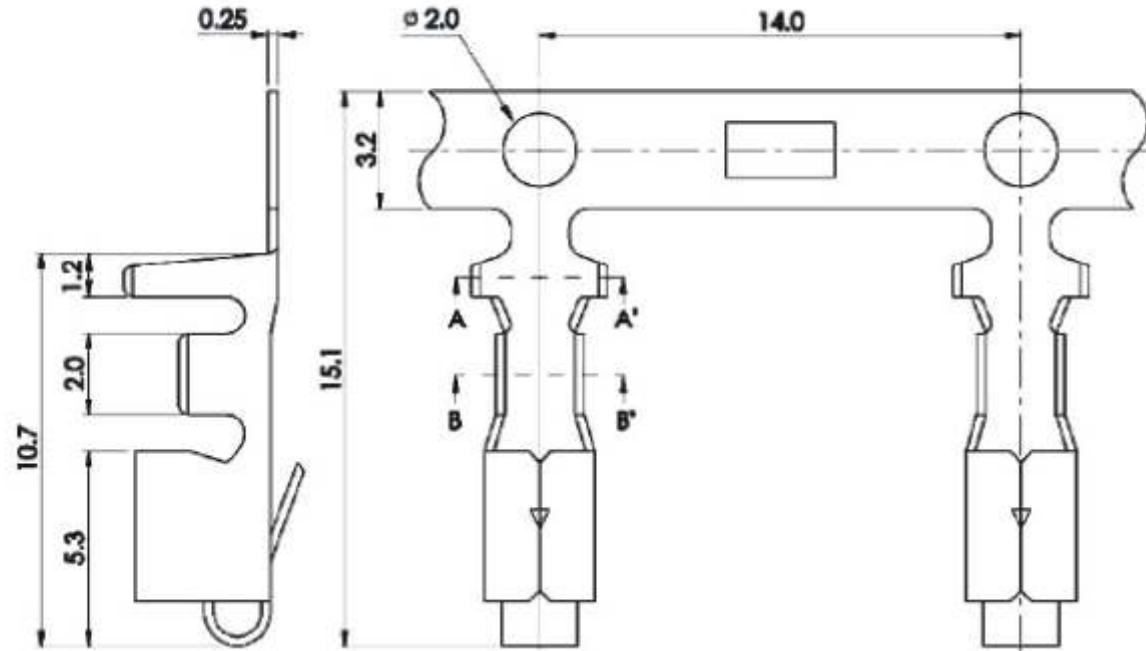
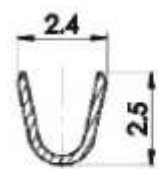

SEC. B-B'

- Terminal
 Material : Brass Pre-Tin
 Applicable Wire : AWG#18 to #22

**HOW TO ORDER:
 MX-5000-T-[]**

1
 1- (R) RoHS Compliant

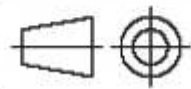
 MATRIX TECNOLOGIA IND. E COM. LTDA.			
UNIT mm	SCALE	TITLE 5,00mm TERMINAL AWG #18 to #22	DATE DECEMBER 2007
TOLERANCE: ±0.25			APP. BY
		MATL	CHK. BY
		DWG. NO.	DR. BY DIEGO